

Angolo/ vertice curvo diam. 30 cm

DIMENSIONI PRODOTTO (mm)			
Codice	grafica visibile	materiale struttura	peso inclusa stampa
PBSTR24	2350X2380	alluminio	9,4 Kg

Diamentro del profilo \varnothing 30 mm

LE MISURE ESPRESSE SONO APPROSSIMATIVE



INDOOR



PERSONALIZZABILE
FRONTE RETRO



STAMPA
IN QUADRICROMIA
IN ALTA DEFINIZIONE



DIAMETRO
PROFILI
 \varnothing 30 mm

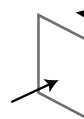

STAMPA
BIFACCIALE

STAND FONDALE FORMA2: stand portatili per fiere
 Stand portatile per fiere trasportabile e facile da allestire.
 Stand composto da struttura di alluminio autoportante con
 inserimento di grafica stampata su tessuto elastico anti piega.
 Utilizzato in ambienti interni, viene fornito con unica borsa di trasporto in
 nylon nero.



TRASPORTABILE IN BORSA MORBIDA

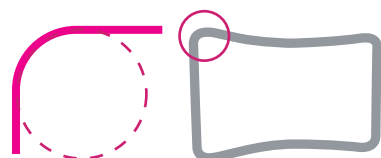
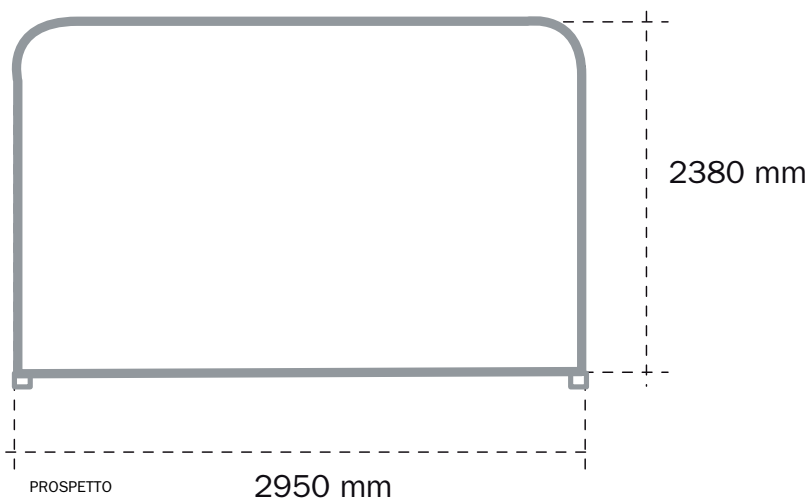

Angolo/ vertice curvo diam. 30 cm

DIMENSIONI PRODOTTO (mm)			
Codice	grafica visibile	materiale struttura	peso inclusa stampa
PBSTRV30	2950X2380	alluminio	9,8 Kg

Diamentro del profilo \varnothing 30 mm

LE MISURE ESPRESSE SONO APPROSSIMATIVE

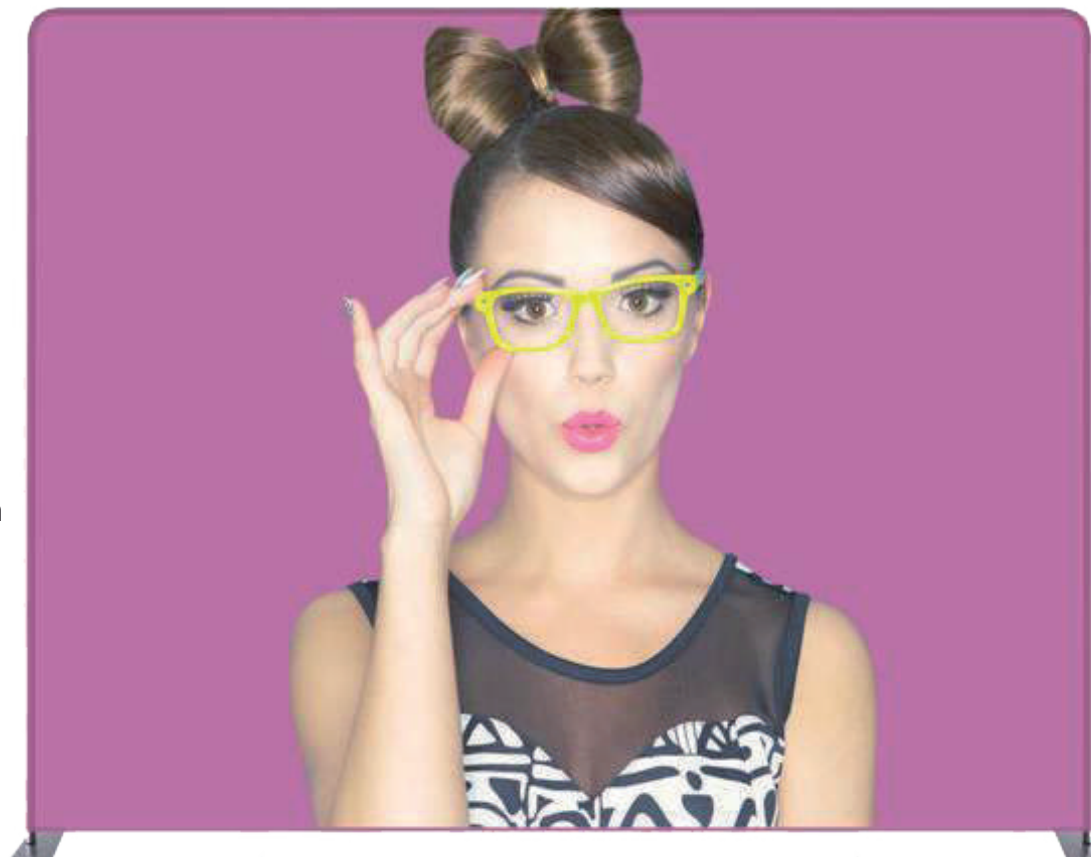

PERSONALIZZABILE
FRONTE RETRO



STAMPA
IN QUADRICROMIA
IN ALTA DEFINIZIONE



DIAMETRO
PROFILI
 \varnothing 30 mm

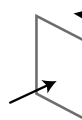

STAMPA
BIFACCIALE

STAND FONDALE FORMA DRITTO: stand portatile per fiere
 Stand portatile per fiere trasportabile e facile da allestire.
 Stand composto da struttura di alluminio autoportante con
 inserimento di grafica stampata su tessuto elastico anti piega.
 Utilizzato in ambienti interni, viene fornito con unica borsa di trasporto in
 nylon nero.



TRASPORTABILE IN BORSA MORBIDA

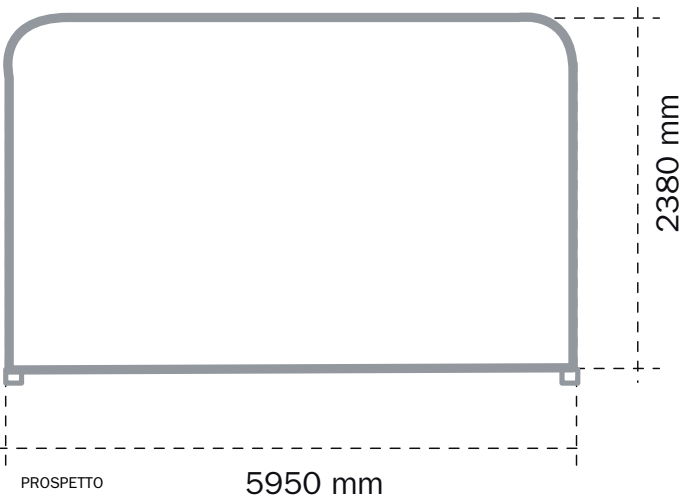
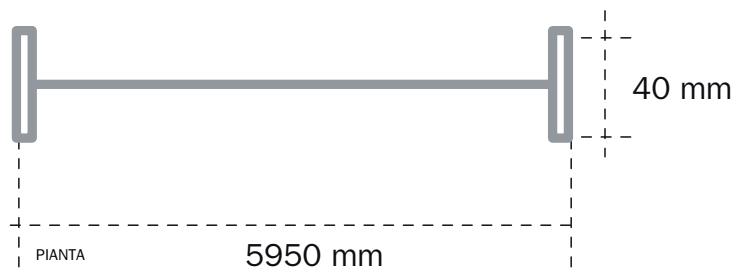

Angolo/ vertice curvo diam. 30 cm

DIMENSIONI PRODOTTO (mm)			
Codice	grafica visibile	materiale struttura	peso inclusa stampa
PBSTRV60	5950X2380	alluminio	17 kg

Diamentro del profilo \varnothing 30 mm

LE MISURE ESPRESSE SONO APPROSSIMATIVE

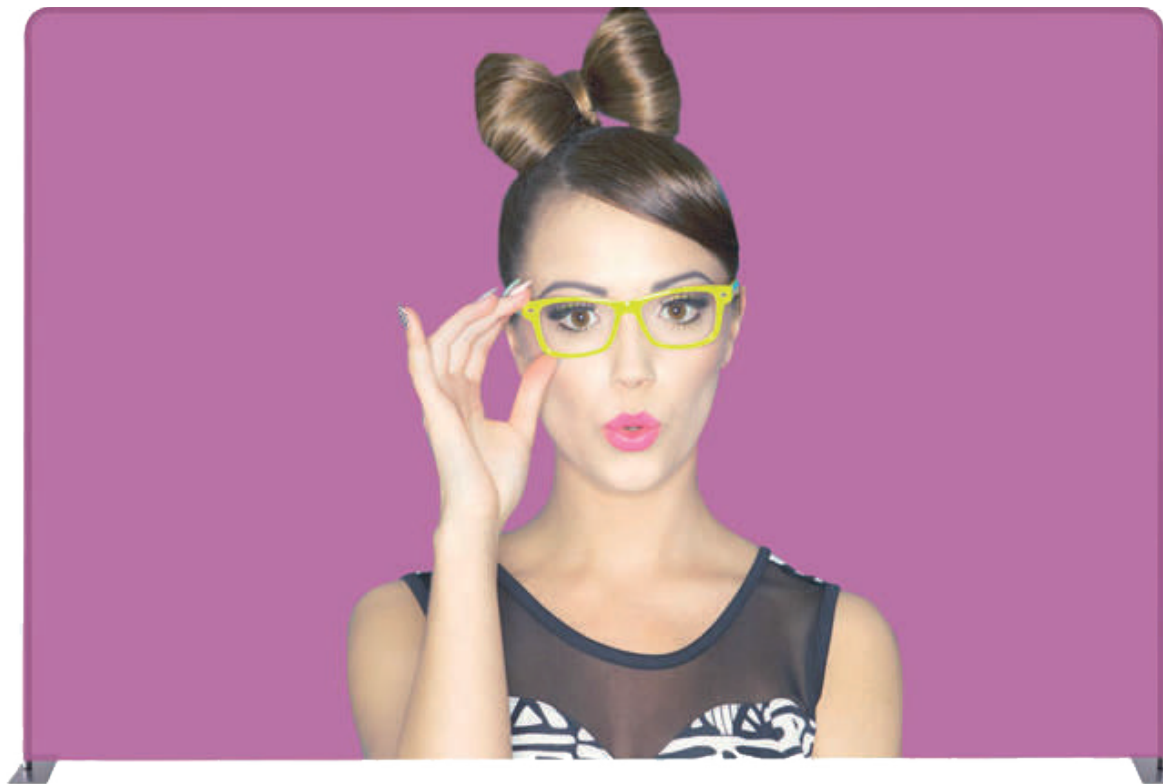

INDOOR



PERSONALIZZABILE
FRONTE RETRO



STAMPA
IN QUADRICROMIA
IN ALTA DEFINIZIONE



DIAMETRO
PROFILI
 \varnothing 30 mm

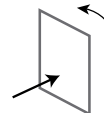

STAMPA
BIFACCIALE

STAND FONDALE FORMA DRITTO: stand portatile per fiere
 Stand portatile per fiere trasportabile e facile da allestire.
 Stand composto da struttura di alluminio autoportante con
 inserimento di grafica stampata su tessuto elastico antipiega.
 Utilizzato in ambienti interni, viene fornito con unica borsa di trasporto in
 nylon nero.



TRASPORTABILE IN BORSA MORBIDA